

Supercal 5 S

Static Thermal Energy Meter



Application

The Supercal 5 S is Sontex's next-generation thermal energy meter, succeeding the well-known Superstatic 440. This new serie is characterised by state-of-the-art multi-functional technologies, is based on a user-friendly modular concept and fully meets customer specific needs as simplified system integration, tariff and data logger functions, universal data transfer and connection to system processors.

Because the design of the Supercal 5 S aim at a high degree of flexibility while keeping future standards in mind, it is ideally suited as a heat or cooling meter, as well as a combined heat/cooling meter. The additional pulse inputs allow the connection of hot or cold water, gas, oil, and electricity meters.

Thanks to its extensive range of options for data communication, as well as its flexibility for collecting and recording dynamic plant data, the Supercal 5 S also lend itself well to applications in district heating networks and industry installations.

Design

The Supercal 5 S heating and cooling thermal energy meter consists of the fluidic oscillator flow sensor, a battery or mains powered calculator and a pair of temperature sensors Sontex 460. Consumption values can easily be read over the display, or over the Software Superprog Windows or Superprog Android. Communication interfaces like optical probe, NFC, M-Bus, BACnet, Modbus, bidirectional SONTEX radio, wM-Bus or LoRaWAN are also available.

Temperature Sensor Pair

The temperature sensors in combination with the Supercal 5 S are Pt 500. The temperature sensors are paired. They are always supplied in pairs and must not be separated, extended or shortened. In the case of temperature sensor pairs with a cable longer than 3 m, we recommend the exclusive use of screened temperature sensor pairs.

Measurement Technique

The calculator Supercal 5 S with mains power supply records every 3 to 30 seconds (depending on the flow) the supply and the return temperature, with battery power (D-type battery) every 10 to 30 seconds (depending on the flow). The recording of the flow is dependent on the pulse value of the flow sensor and is constantly updated. With the mean flow rate, the temperature difference and the heat coefficient the energy is calculated of the captured medium and displayed on the 128 × 64 pixels illuminated dot-matrix.

Multifunctional Calculator

Innovations

- Optimisation of the housing for easier installation
- NFC technology for simplified and user-friendly configuration using Superprog Android.
- Large illuminated dot-matrix display (128 × 64) for improved navigation
- 2 LEDs indicate, in real time, the status of the Calculator
- Fully customisable tariff and data logger functions
- Extended data logging (up to 2 175 entries)
- Modular concept: power supplies, communication & inputs/outputs
- Increased space for cabling

Features

- Calculator for heat meters, cooling meters or combined heat/cooling meters
- Battery or mains powered for increased flexibility
- Exchangeable calculator upper part while wiring remains in place
- Modules can be retrofitted or replaced at any time without affecting the approval
- Self-recognition of optional modules
- Native M-Bus or two extension slots (BACnet, Modbus, and other)
- Optical interface according to IEC 62056-21:2002
- 2- or 4-wire sensors without any configuration
- 2 pulse/state inputs and 2 pulse/state open drain outputs
- User-friendly menu navigation
- Accuracy better than required by EN 1434

Optional Power Supply Modules

One plug and play power supply module can be retrofitted, either Ex Works or on site, or replaced at any time without affecting the approval of the calculator. The calculator recognises automatically the following types of power supplies:

- D Battery 3,6 V
- Mains 24 V (12 VAC to 36 VAC or 12 VDC to 42 VDC)
- Mains 230 VAC (110 VAC to 240 VAC, 50/60 Hz)

Optional Modules

Up to two plug and play modules can be retrofitted, either Ex Works or on site, or replaced at any time without affecting the approval of the calculator. The calculator recognises automatically the following types of modules:

- Analog module with 2 inputs (0..20 mA, 4..20 mA, 0(2) V .. 10 VDC)
- Digital module with 2 inputs (state/pulse)
- Digital module with 2 outputs (state/pulse)
- M-Bus
- BACnet/Modbus

Data Logger

The calculator's data logger is fully customisable and allows the following recordings:

- Up to 4 totalizer's values
- Average values
- Maximum values
- Event log

The only limitation is given by the available memory, which is 10 kB. Each value takes 4 bytes of storage except the maximum values and the event log values that take 8 bytes. Therefore, up to 2 175 values can be recorded.

Optional Radio communication

- SONTEx radio
 - Frequency: 433.82 MHz
 - Communication: Bidirectional
 - Protocol: Radian 0
 - Encryption: AES-128
 - Broadcasting performance: 10 mW (10 dbm)
- wM-Bus
 - Frequency: 868.95 MHz
 - Communication: Unidirectional
 - Protocol: Wireless M-Bus according to EN 13757-4
 - Encryption: AES-128
 - Broadcasting interval: Standard 120 sec. (Mode T1/C1, encryption mode 5/7)
 - Broadcasting performance: 25 mW (14 dbm)
- LoRaWAN
 - Frequency: 868.95 MHz, EU868, norme by ETSI (EN300.220)
 - Communication: Bidirectional
 - Protocol: Radian – EN60870-5 (M-Bus)
 - Encryption: AES-128
 - Broadcasting performance: 25 mW (14dBm)
 - Cycle: Standard every 2 hours

Dimensions

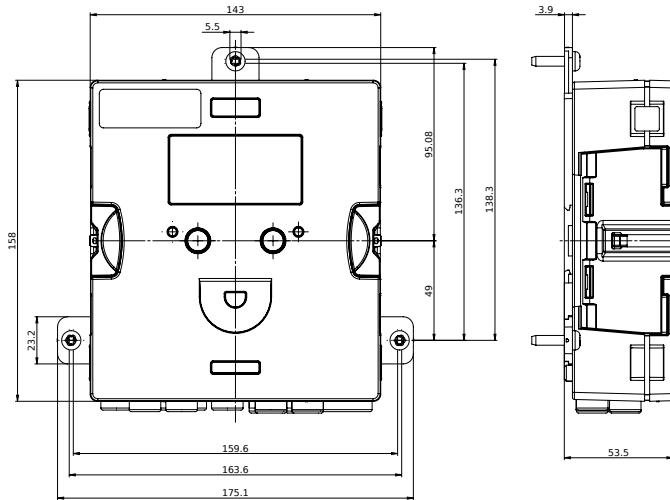

Compatibility Matrix

Fonction	w/o any ¹ Power Supply	D Battery	Mains Operated
LCD display	✓	✓	✓
Backlight (LCD display)			✓ ²
NFC interface	✓	✓	✓
Optical interface	✓	✓	✓
M-Bus interface	✓	✓	✓
Outputs	5 Hz	200 Hz	200 Hz
Inputs	5 Hz	200 Hz	200 Hz
Measurement cycle	Slow	Fast	Fast
Energy measurement (temperatures and volume)	✓	✓	✓
Supply of the flow meter		✓	✓
Radio		✓	✓
Communication Modules ³	✓	✓	✓
Life span (years)	6+1	12+1	⁴

¹ Only with Backup battery.

² In case of power cut is no backlight

³ Modules work always. Any other communication module requires an external main power supply.

⁴ The backup battery can keep the device working only up to 3 months.

Technical Data

Temperature Measurement	<ul style="list-style-type: none"> ■ Type of temperature sensor ■ Cabling ■ Absolute temperature range ■ Approved range ■ Homologation range ■ Response limit ■ Temperature resolution t ■ Temperature resolution Δt ■ Environmental class A 	Pt500 according to EN60751 2- or 4-wires -20°C to 200°C 1°C to 200°C 3 K to 150 K 0,2 K 0,1 K 0.01 K E1/M1
Measuring Cycle	<ul style="list-style-type: none"> ■ Temperature measurement ■ Battery operated ■ Mains operated 	10 – 30 s 3 – 30 s
Temperature	<ul style="list-style-type: none"> ■ Operation ■ Storing and transport 	5°C to 55°C -20°C to 70°C (dry environment)
Display	<ul style="list-style-type: none"> ■ Illuminated dot-matrix 	128 × 64 pixels
Display Units	<ul style="list-style-type: none"> ■ Energy ■ Volume ■ Additional pulse inputs ■ Temperature 	kWh, MWh, MJ, GJ, kBtu, MBtu, Mcal, Gcal L, m ³ , gal (US), kgal (US), ft ³ Energy or volume °C, °F
Lifespan Supply Modules	<ul style="list-style-type: none"> ■ D battery ■ Mains 230 VAC ■ Mains 24 VDC / 24 VAC 	12 + 1 years - -
Degree of Protection	<ul style="list-style-type: none"> ■ IP-Code 	IP 65 in accordance to IEC 60529
Pulse Inputs	Frequencies <ul style="list-style-type: none"> ■ Without supply ■ D battery ■ Mains Input voltage	maximum 5 Hz maximum 200 Hz maximum 200 Hz 0 to 30 V
Pulse Outputs	Frequencies <ul style="list-style-type: none"> ■ Without supply ■ D battery ■ Mains Output voltage	maximum 5 Hz maximum 200 Hz maximum 200 Hz 0 to 60 V
Optical Interface	<ul style="list-style-type: none"> ■ Interface 	according to IEC 62056-21:2002
NFC Interface	<ul style="list-style-type: none"> ■ Interface 	according to ISO/IEC 14443 Type A
M-Bus Interface	<ul style="list-style-type: none"> ■ Interface ■ Baud rate 	according to EN 13757-2/3 300 to 9600 baud

Flow Meter Supercal 5 S

Fluid Oscillator Flow Sensor: The principle

Picture 1: The main part of the flow passes through a Venturi nozzle in the pipe, creating the differential pressure to bypass the other part of the flow through the fluid oscillator. In the oscillator the liquid is led to a nozzle and accelerated to a jet. Opposite of the nozzle the jet is redirected to the left or right into a channel that leads upwards to the sensor head equipped with a piezo sensor. The pressure of the liquid on the sensor creates an electrical pulse. The liquid flows back to the pipe through a return loop and redirects the jet into the other channel where the action is repeated and fluid oscillation is created. The frequency of this oscillation is linear proportional to the volume flow. A supplementary benefit is the self cleaning effect due to the oscillating character.

Picture 2: The animated top view on the oscillator shows the differences of velocity of the liquid. The jet accelerated by the nozzle with the highest velocity in red, slow velocity in blue.

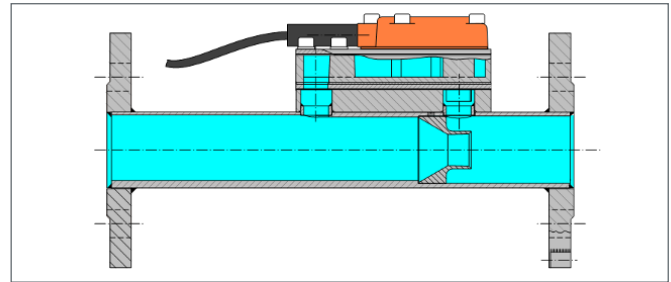

Picture 1: Section through the flow sensor

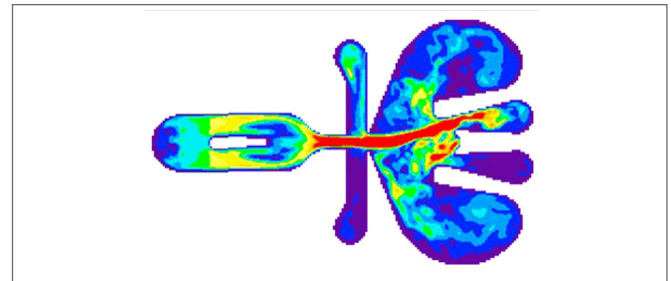

Picture 2: fluidic oscillation with jet (RED)

Main Features

The thermal energy meters Supercal 5 S are optimized for the measurement and calculation of energy consumption in district heating systems. They are also extremely well suited to use purely as volumetric flow meters for various media.

- Interchangeable measuring head
- Complete range of pipes 1 – 1500 m³/h
- Purchase and maintenance costs are reasonable compared with other static flow sensors
- Corrosion resistant materials
- Protection degree of flow sensor IP68
- Threaded and flanged fittings
- Straight sections of piping of 3 DN in flow and return of any flow meter or heat meter must be respected. For the Supercal 5 S up to DN 40 (qp10) the straight sections of piping of 3 DN are already included in the length of the flow sensor
- No moving parts, therefore no wear
- Not sensitive to dirt
- Stable
- For horizontal, upstream and downstream pipes, independent mounting position
- Common spare parts qp 1 – 1500 m³/h
- Dynamic range: 1:100 at qp 1 – 25 m³/h
1:50 at qp 40 – 400 m³/h
1:25 at qp 800 – 1500 m³/h
- Direct pick-up of voltage pulses without reflectors
- Measurement independent of medium
- Long-term, stable, accurate and reliable measurement, even with poor water quality

Technical Data Flow Meter Supercal 5 S

Dimensions

Material : Brass (DN 15 – DN 40)

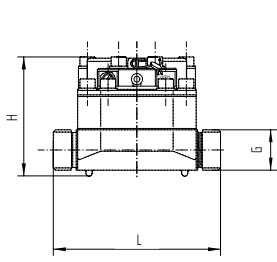

Fig1

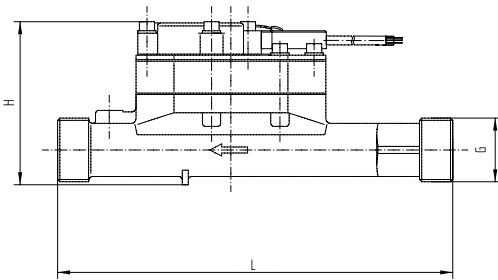

Fig2

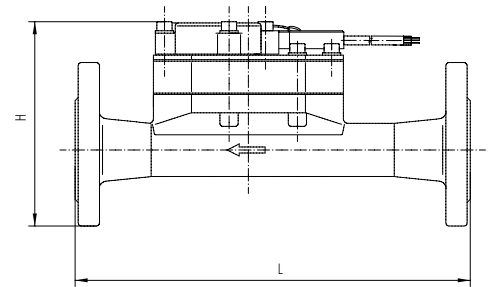
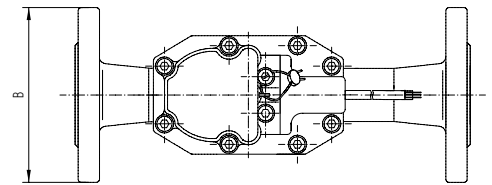
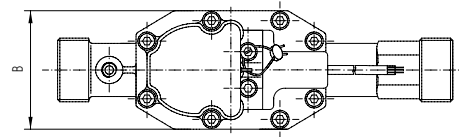
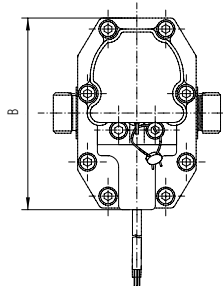

Fig3



qp	DN	G	PN	Fig.No	B (mm)	H (mm)	L(mm)	h (Ø mm)	# bolts (M)
1 m ³ /h	-	¾"	16/25	1	125	79	110		
1 m ³ /h	-	1"	16/25		125	79	190		
1,5 m ³ /h	-	¾"	16/25		125	79	110		
1,5 m ³ /h	-	1"	16/25		125	79	190		
2,5 m ³ /h	-	1"	16/25		125	79	190		
3,5 m ³ /h	-	1 ¼"	16/25	2	78	105	260		
3,5 m ³ /h	25	-	16/25	3	115	134	260	Ø 85	4 (M 12)
6 m ³ /h	-	1 ¼"	16/25	2	78	105	260		
6 m ³ /h	25	-	16/25	3	115	134	260	Ø 85	4 (M 12)
10 m ³ /h	-	2"	16/25	2	78	122	300		
10 m ³ /h	40	-	16/25	3	150	157	300	Ø 110	4 (M 16)

Technical Data Flow Meter Supercal 5 S

Dimensions:

Material: Stainless steel (DN 50 – DN 250)

Material: Spheroidal cast iron (DN 50 – DN 150)

Material: Steel (DN 350 – 500)

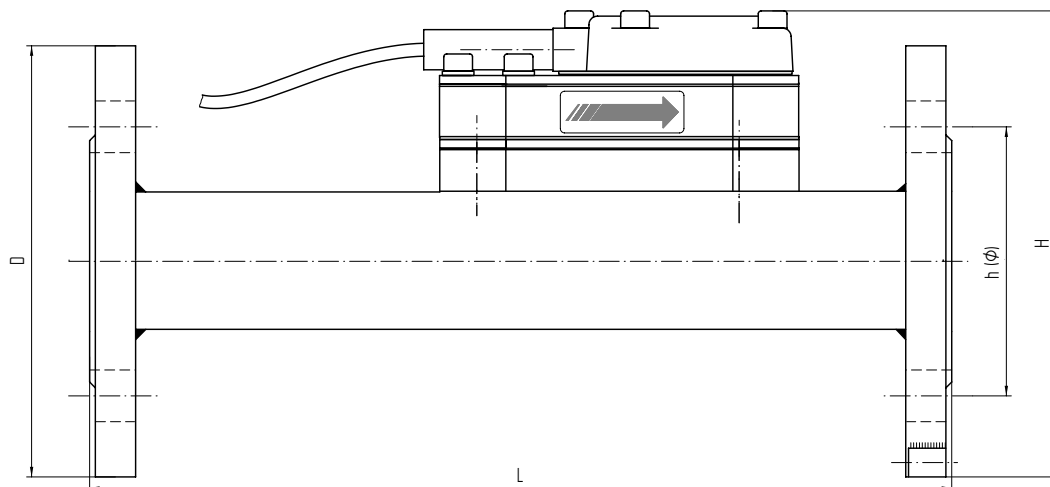

qp	DN	PN	L (mm)	D (mm)	H (mm)	h (Ø mm)	# bolts (M)
15 m³/h	50	16,25	270	165	171	Ø 125	4 (M 16)
25 m³/h	65	16,25	300	185	189	Ø 145	8 (M 16)
40 m³/h	80	16,25	225	200	203	Ø 160	8 (M 16)
40 m³/h	80	16,25	300	200	203	Ø 160	8 (M 16)
60 m³/h	100	16	250	220	226	Ø 180	8 (M 16)
60 m³/h	100	25	250	235	235	Ø 190	8 (M 20)
60 m³/h	100	16	360	220	226	Ø 180	8 (M 16)
60 m³/h	100	25	360	235	235	Ø 190	8 (M 20)
100 m³/h	125	16	250	250	254	Ø 210	8 (M 16)
100 m³/h	125	25	250	270	270	Ø 220	8 (M 24)
150 m³/h	150	16	300	285	286	Ø 240	8 (M 20)
150 m³/h	150	25	300	300	300	Ø 250	8 (M 24)
150 m³/h	150	16	500	285	286	Ø 240	8 (M 20)
150 m³/h	150	25	500	300	300	Ø 250	8 (M 24)
250 m³/h	200	16	350	340	340	Ø 295	12 (M 20)
250 m³/h	200	25	350	360	360	Ø 310	12 (M 24)
400 m³/h	250	16	450	405	405	Ø 355	12 (M 24)
400 m³/h	250	25	450	425	425	Ø 370	12 (M 27)
800 m³/h	350	10	500	505	505	Ø 460	16 (M 20)
800 m³/h	350	16	500	520	520	Ø 470	16 (M 24)
1,500 m³/h	500	10	500	670	670	Ø 620	20 (M 24)
1,500 m³/h	500	16	500	715	715	Ø 650	20 (M 30)

Flanges according to standard DIN-EN 1092-1/DIN 2501/ISO 7005-1

Technical Data Flow Meter Supercal 5 S

qp	Threaded connection	Flanged connection	Length	Mat.	PN	Maximal flow qs	Minimal flow qi	Low flow threshold value (50°C)	Threaded hole for sensor	Weight.	Kvs value (at 20°C)	Pressure loss at qp
m³/h	G"	DN	mm		PN	m³/h	l/h	l/h		kg	m³/h	bar
	(EN ISO 228-1)	(ISO 7005-3)										
1	3/4"	(15)	110	Brass	16/25	2	10	7	Yes	2,9	2,09	0,20
1	1"	(20)	190	Brass	16/25	2	10	7	Yes	3,2	2,09	0,20
1,5	3/4"	(15)	110	Brass	16/25	3	15	11	Yes	2,9	2,06	0,25
1,5	1"	(20)	190	Brass	16/25	3	15	11	Yes	3,2	5,44	0,09
2,5	1"	(20)	190	Brass	16/25	5	25	18	Yes	3,2	5,21	0,25
3,5	1 1/4"	(25)	260	Brass	16/25	7	35	25	Yes	3,5	7,46	0,16
3,5		25	260	Brass	16/25	7	35	25		5,4	7,46	0,16
6	1 1/4"	(25)	260	Brass	16/25	12	60	42	Yes	3,5	13,4	0,16
6		25	260	Brass	16/25	12	60	42		5,4	13,4	0,16
10	2"	(40)	300	Brass	16/25	20	100	70	Yes	4,5	20,9	0,25
10		40	300	Brass	16/25	20	100	70		8,1	20,9	0,25
		(ISO 7005-1)										
15		50	270	SS/CI	16/25	30	150	105		9,1	31,6	0,25
25		65	300	SS/CI	16/25	50	250	175		11,2	51,8	0,25
40		80	225	SS	16/25	80	800	560		14,4	142	0,09
40		80	300	SS/CI	16/25	80	800	560		13,1	142	0,09
60		100	250	SS	16/25	120	1200	840		NA	210	0,10
60		100	360	SS/CI	16/25*	120	1200	840		19,0	210	0,10
100		125	250	SS/CI	16/25*	200	2000	1400		NA	343	0,10
150		150	300	SS/CI	16/25*	300	3000	2100		27,2	514	0,10
150		150	500	SS	16/25	300	3000	2100		NA	514	0,10
250		200	350	SS	16/25	500	5000	3500		NA	857	0,10
400		250	450	SS	16/25	800	8000	5600		38,1	1'372	0,10

SS: Stainless Steel; CI: Spheroidal cast iron*: PN 25 only SS

						m³/h	m³/h	m³/h				
800		350	500	Steel	10/16	1600	32	22		90/105	2,667	0,10
1500		500	500	Steel	10/16	3000	60	42		130/195	5,000	0,10

Degree of protection	■ Standard	IP68
Ambient Temperatures	■ Operation	5 ... 55°C
	■ Storing and transport	-25 ... 70°C
Measurement	■ Approved temperature range	5 ... 130°C

Pressure Loss

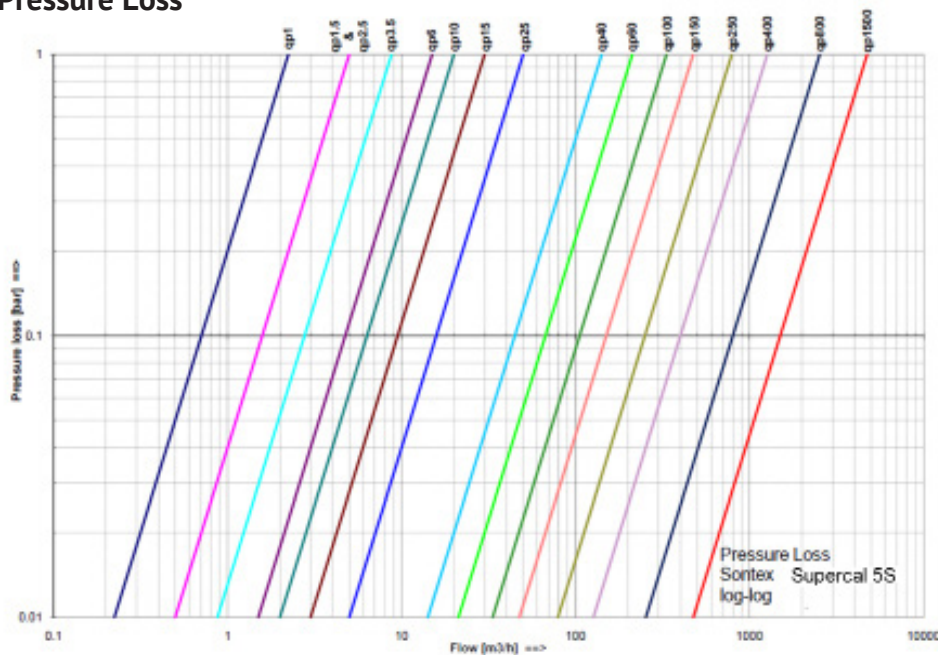

CE Conformity

according to Directive MID 2014/32/EU
according to RED 2014/53/EU

UKCA Conformity

Technical Support

For technical support, please contact your local Sontex agent or Sontex SA directly.

Sontex Hotline

sontex@sontex.ch, +41 32 488 30 04

Specifications are subject to change without notice.